



CARDIO

DIO

VASCULAR

SUMÁRIO

Cooley Atrial	4
Dinkhuysen	5
Kirklin	5
Ankeney	6
Burford	7
Davidson	7
Finochietto	8
Allison Lung	9
Harrington	9
De Bakey	10
Diethrich	11
Castañeda	12
Castañeda S	13
Cooley	14
De Bakey	15
De Bakey Potts	22
De Bakey-Beck	23
De Bakey-Glover	24
Derra	25
Lambert-Kay	26
Leland-Jones	26
Ordenha	27
Saca Cálculo	28
Pinça para Válvula Mitral	29
Satinsky	30
Lahey	31
Lower	31
Semb	31
Carótida	32
Denis	33
Dietrich	33
Dinkhuysen	33
Punch Aórtico	34
Boyd	35
Dietrich	37
Potts de Martel	40
Metzenbaum Córdio	41
De Bakey	42
Porta agulhas para Coronária	43
Conjunto Flebo Extrator	44

Cooley Atrial

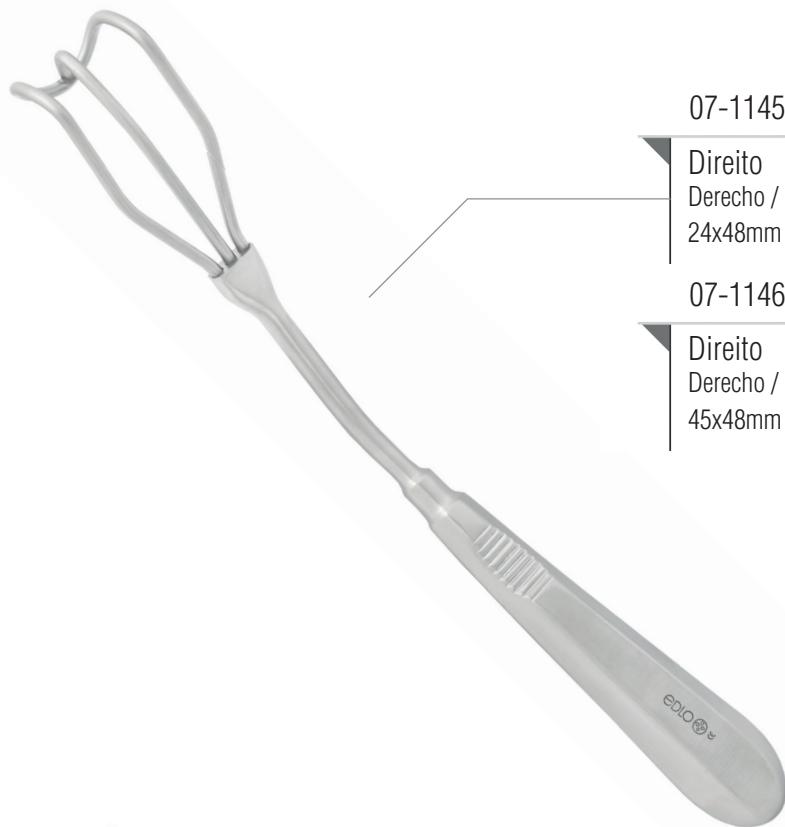

07-1145

Direito
Derecho / Right
24x48mm 21,5cm | 8 1/2"

07-1146

Direito
Derecho / Right
45x48mm 21,5cm | 8 1/2"

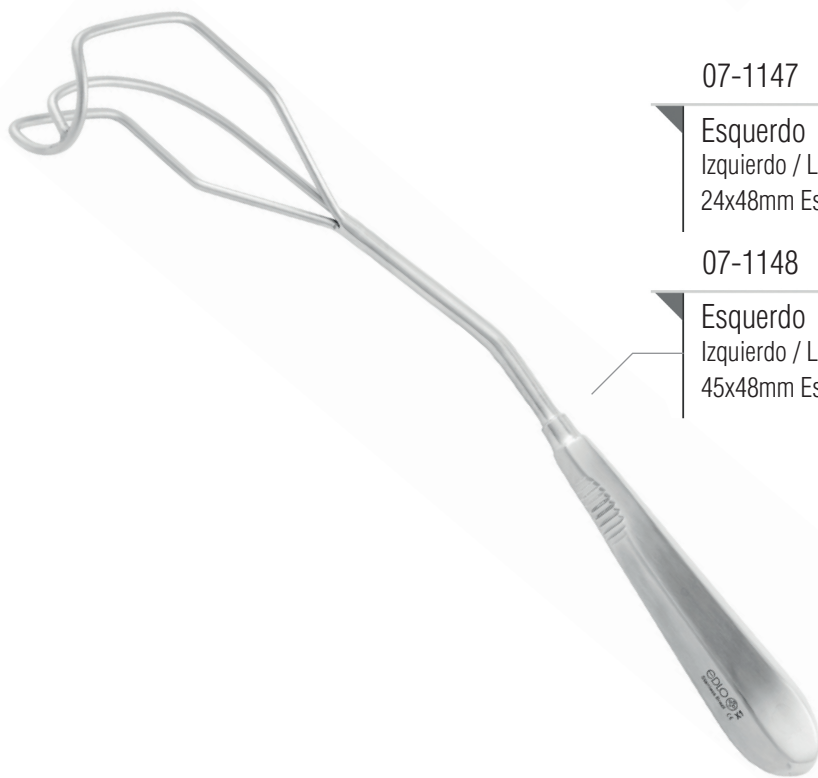

07-1147

Esquerdo
Izquierdo / Left
24x48mm Esquerdo 21,5cm | 8 1/2"

07-1148

Esquerdo
Izquierdo / Left
45x48mm Esquerdo 21,5cm | 8 1/2"

Dinkhuysen

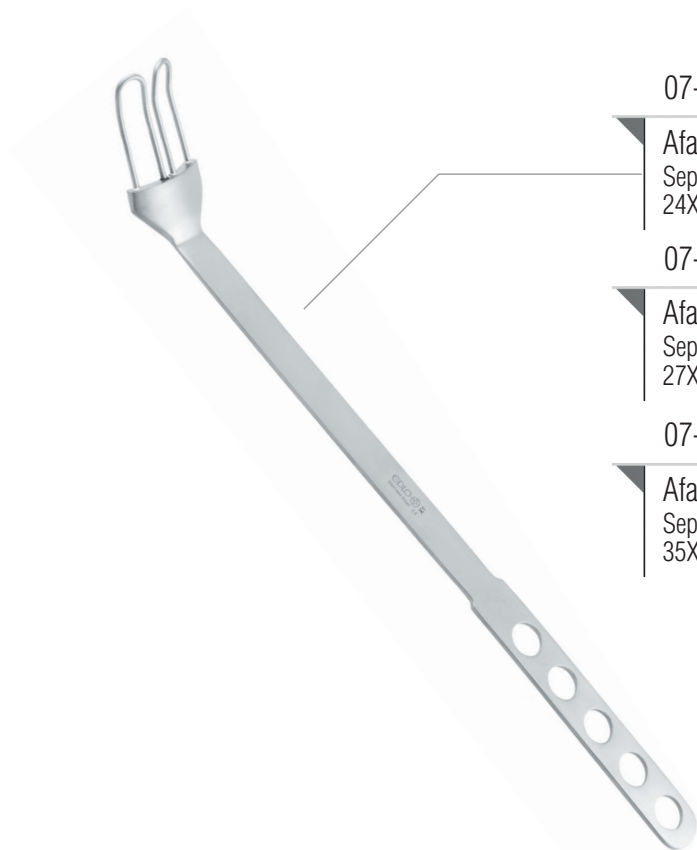

07-2898

Afastador Aorta
Separador de Aorta / Aorta Retractor
24X20mm

07-2899

Afastador Aorta
Separador de Aorta / Aorta Retractor
27X22mm

07-2900

Afastador Aorta
Separador de Aorta / Aorta Retractor
35X25mm

Kirklin



07-1138

10mm 18cm | 7"

07-1139

15mm 18cm | 7"



07-2896

5mm 18cm | 7"



07-2897

7mm 18cm | 7"



Ankeney

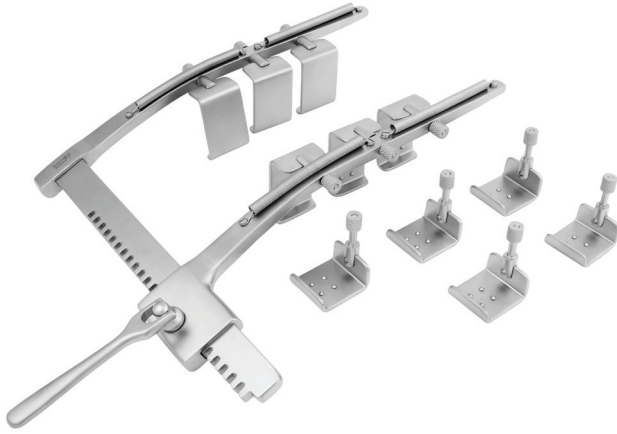

01-0801

Grande
Grande / Large

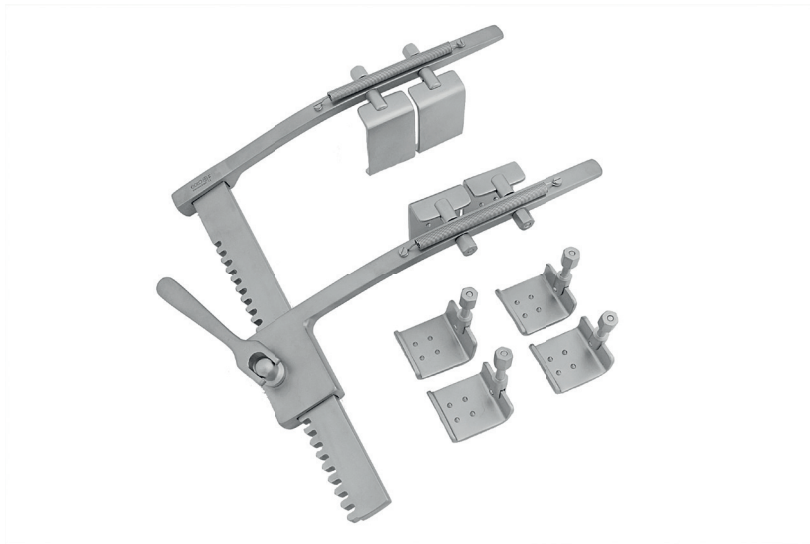

01-0901

Médio
Medium / Medio



01-2506

Infantil
Niño / Small

Burford

01-0786

Válvulas:

Pequena Reta 63x61mm

Grande Reta 73x61mm

Pequena Curva 51x61mm (Intercambiáveis)

Lâminas:

Pequena Recta 63x61mm

Grande Recta 73x61mm

Pequena Curva 51x61mm (Intercambiável)

Blades:

Small Straight 63x61mm

Big Straight 73x61mm

Small Curved 51x61 (Interchangeable)

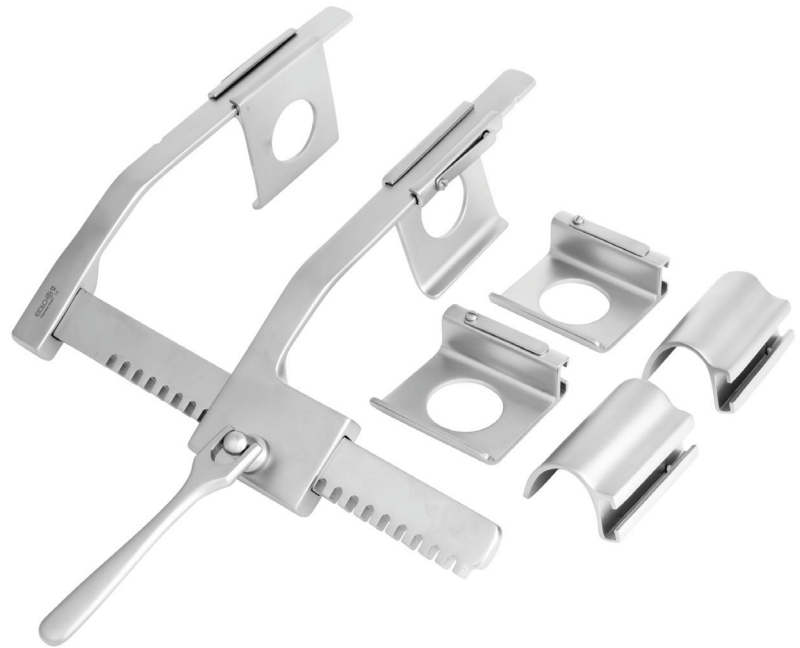

AFASTADORES DE TÓRAX

Separadores / Scapula Retractors

Davidson

01-2776

75X50mm 16cm | 6 1/4" (escápula)

01-2777

75X90mm 16cm | 6 1/4" (escápula)



Finochietto

01-0023

Baby
Bebé / Baby
16X18X72X70mm

01-0024

Infantil
Niño / Small
35X45X130X170mm

01-0025

Médio
Medio / Medium
47X54X165X188mm

01-0026

Adulto
Adulto / Adult
47X54X170X220mm

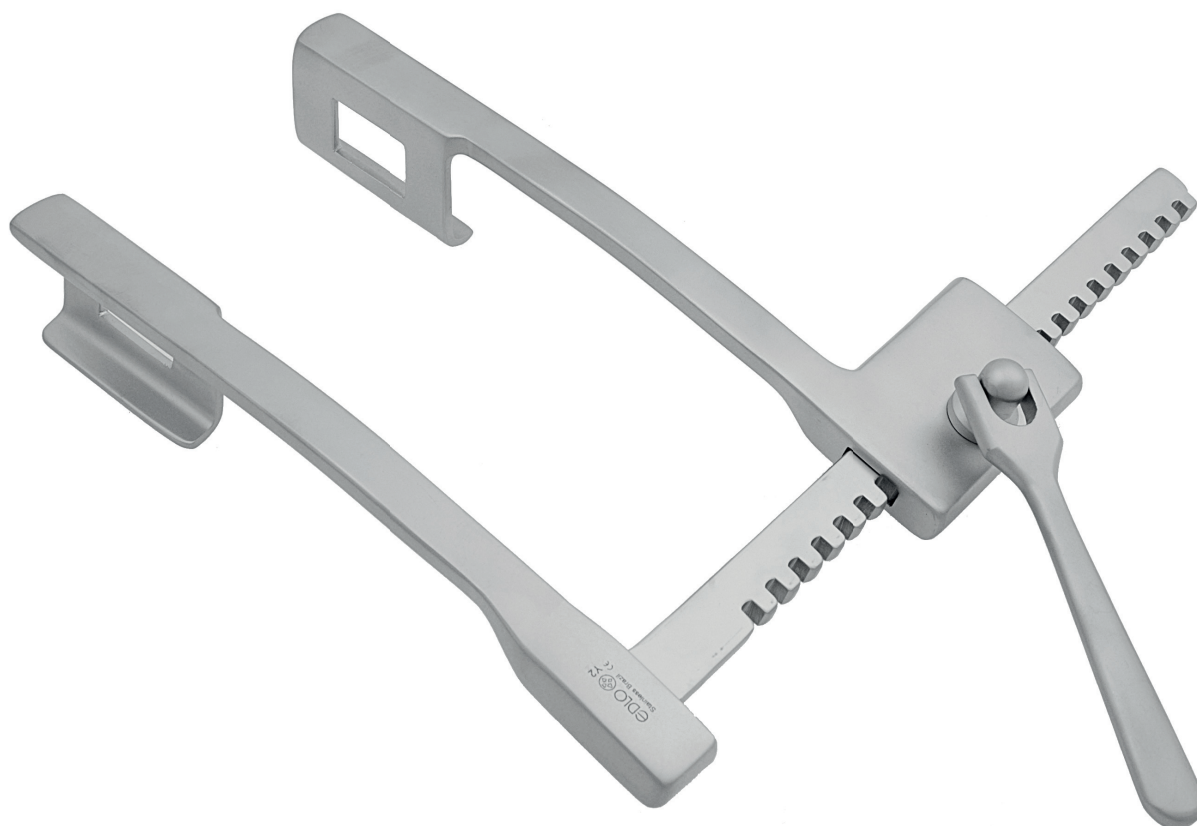

Allison Lung

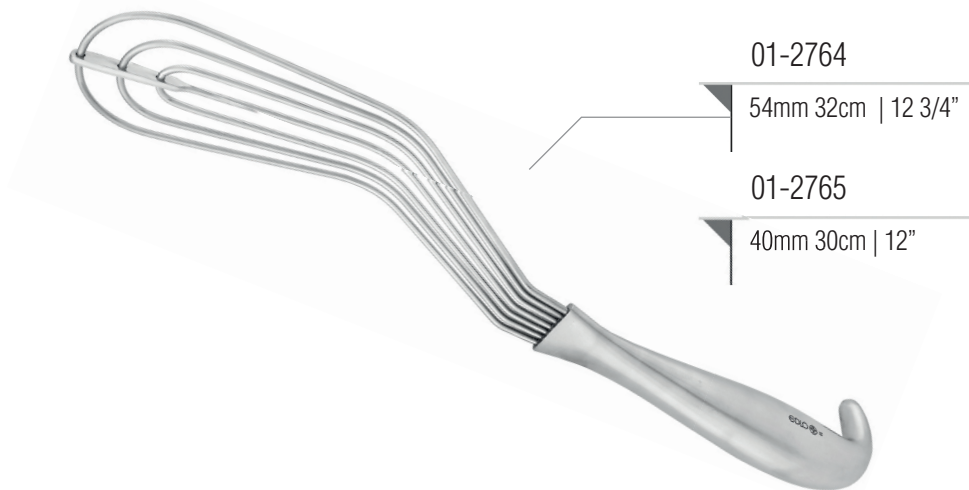

Harrington



Pinça De Bakey



Curva
Curvo / Curved

07-2990

5,5cm | 2 1/4"

07-0553

8,5cm | 3 1/2"



07-0716

9,5cm | 3 3/4"



07-0717

10,5cm | 4 1/4"



07-0718

11,5cm | 4 1/2"

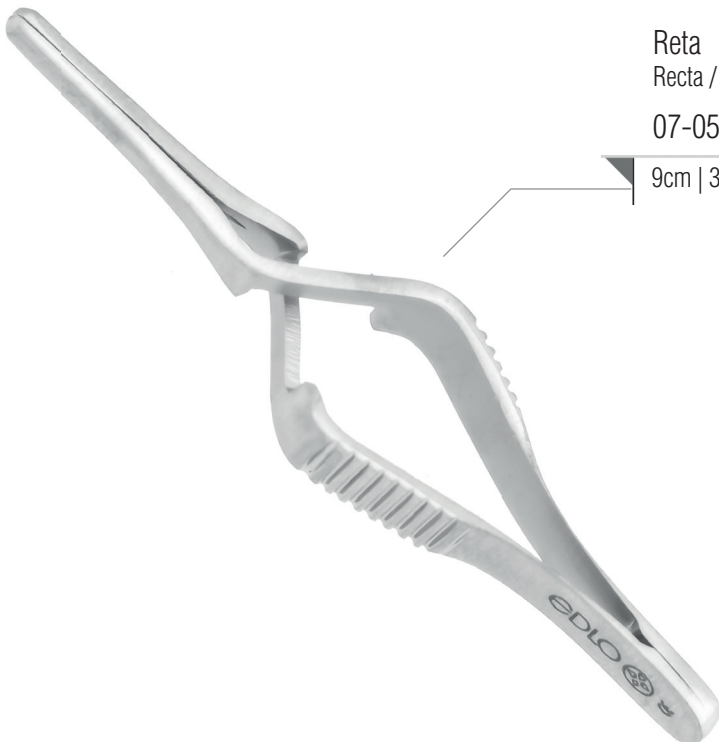

Reta
Recta / Straight

07-0552

9cm | 3 1/2"

07-0713

10cm | 4"



07-0714

11cm | 4 1/4"



07-0715

12cm | 4 3/4"

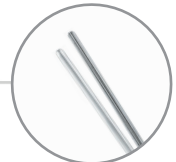

07-2991

5,5cm | 2 1/4"



Diethrich



Curva
Curvo / Curved

07-0795

6cm | 2 1/2"

07-0796

5,5cm | 2 1/4"



07-0797

5cm | 2"



Reta
Recta / Straight

07-0792

6,5cm | 2 9/16"

07-0793

6cm | 2 1/2"



07-0794

5,5cm | 2 1/4"



Castañeda



07-3023

48mm 30° 13cm | 5"



07-3024

48mm 45° 13cm | 5"



07-3025

48mm 90° 11cm | 4 1/4"

07-3026

Reta
Recta / Straight
48mm 13cm | 5"

Castañeda S

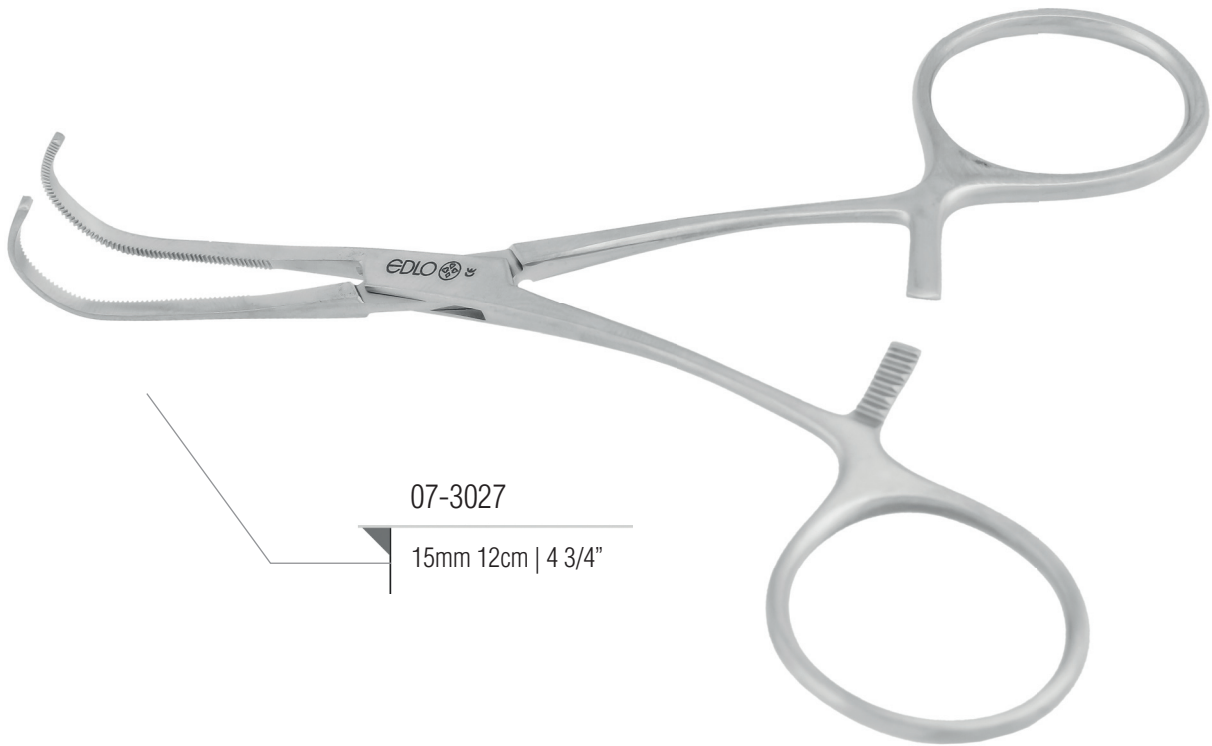

07-3027

15mm 12cm | 4 3/4"

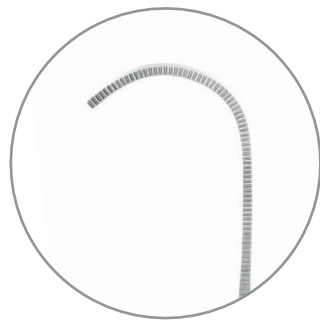

07-3028

18mm 12cm | 4 3/4"

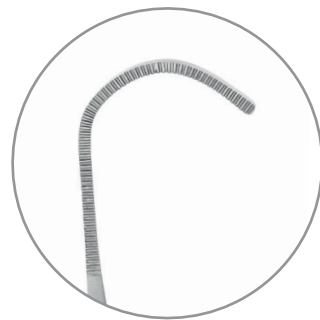

07-3029

23mm 12cm | 4 3/4"

07-3030

25mm 17cm | 6 3/4"

Cooley



Clamp de Anastomose
Anastomosis Clamp / Anastomosis Clamp

07-2885

15mm 15,5cm | 6 1/2"



07-2886

20mm 15cm | 6"



07-2887

25mm 16cm | 6 1/4"

De Bakey



07-0541

Angulada
Angular / Angled
75mm 60° 18cm | 7"

07-3033

Angulada
Angular / Angled
90mm 60° 20cm | 8"

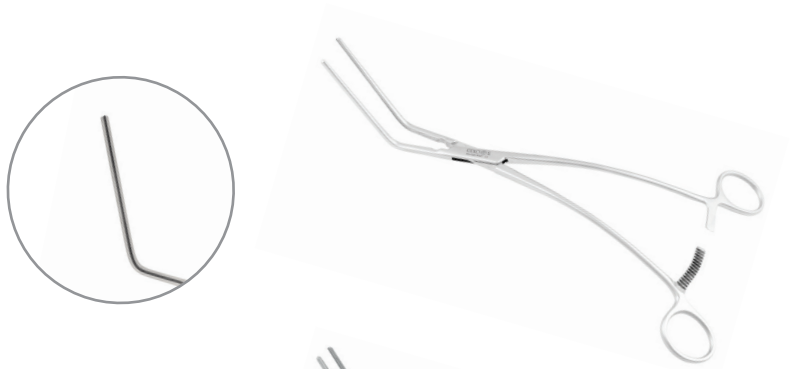

07-0549

Angulada
Angular / Angled
90mm 60° 28cm Aorta



07-2958

Angulada
Angular / Angled
90mm 60° 32cm | 12 1/2"



07-1335

Angulada
Angular / Angled
40mm 45° 13cm | 5"

07-3034

Angulada
Angular / Angled
40mm 90° 12cm | 4 3/4"

De Bakey



07-0542

Coarctação Reta
Coartación Clamp Recta
Coarctation Clamp Straight
55mm 21cm | 8 1/2"



07-0544

Coarctação Reta
Coartación Clamp Recta
Coarctation Clamp Straight
75mm 22cm | 8 3/4"



07-0543

Coarctação Angulada no Cabo
Coartación Clamp Mango Angular
Coarctation Clamp Angled Handle
75mm 22cm | 8 3/4"

07-3035

Coarctação Angulada no Cabo
Coartación Clamp Mango Angular
Coarctation Clamp Angled Handle
75mm 24cm | 9 1/2"

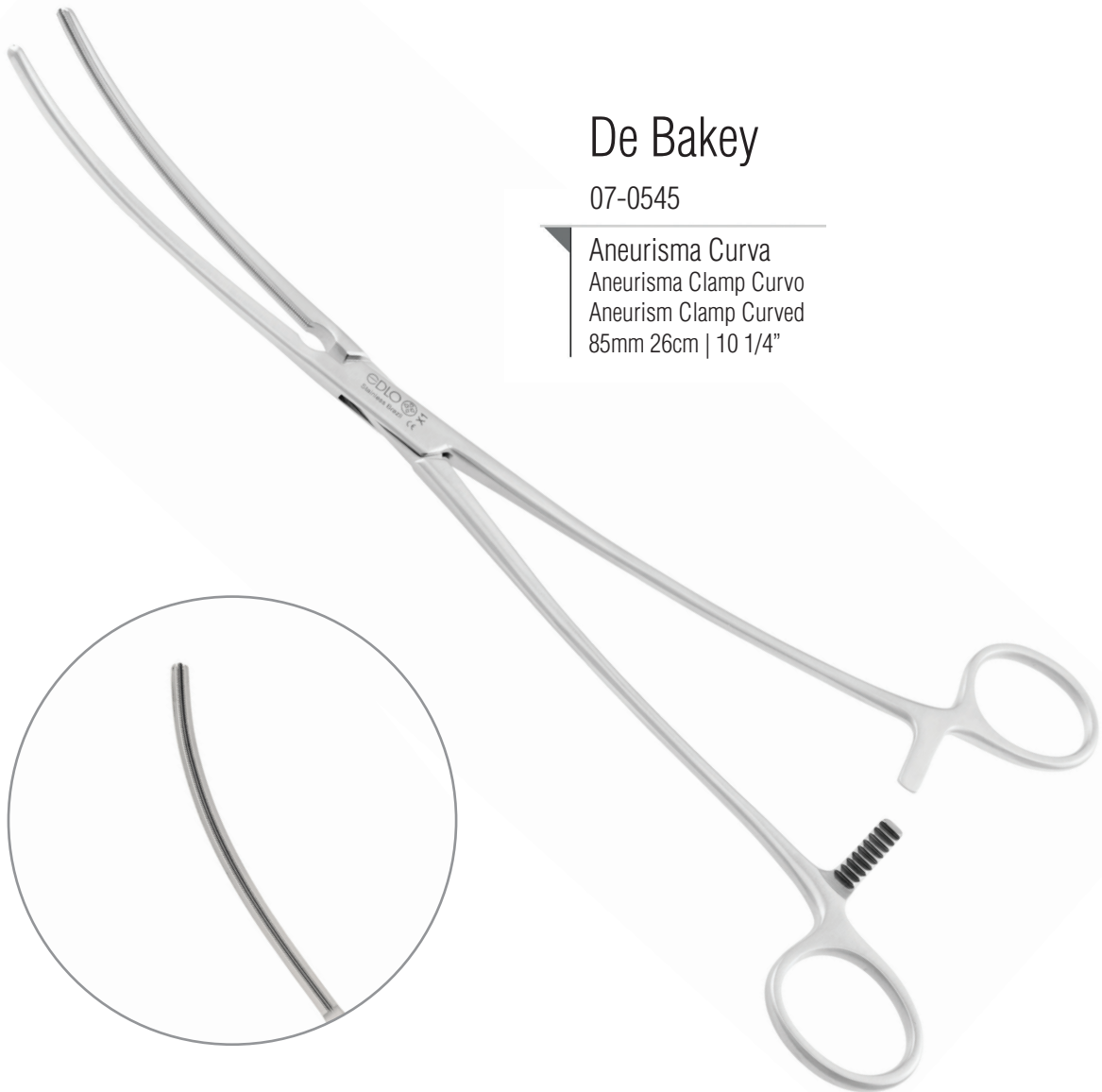

De Bakey

07-0545

Aneurisma Curva
Aneurisma Clamp Curvo
Aneurism Clamp Curved
85mm 26cm | 10 1/4"

De Bakey



07-0555

Curvo
Curvo / Curved
45mm 12,5cm | 5"



07-0703

Curvo
Curvo / Curved
45mm 12,5cm | 5"



07-0551

Curvo
Curvo / Curved
55mm 17cm | 6 3/4"

07-3039

Curvo
Curvo / Curved
60mm 16cm | 6 1/4"

De Bakey



07-0723

Curvo
Curvo / Curved
60mm 18cm 7"

07-3031

Curvo
Curvo / Curved
65mm 18cm | 7"

07-3040

Curvo
Curvo / Curved
60mm 20cm | 8"



07-0546

Curvo
Curvo / Curved
70mm Curva 26cm | 10 1/4"

De Bakey

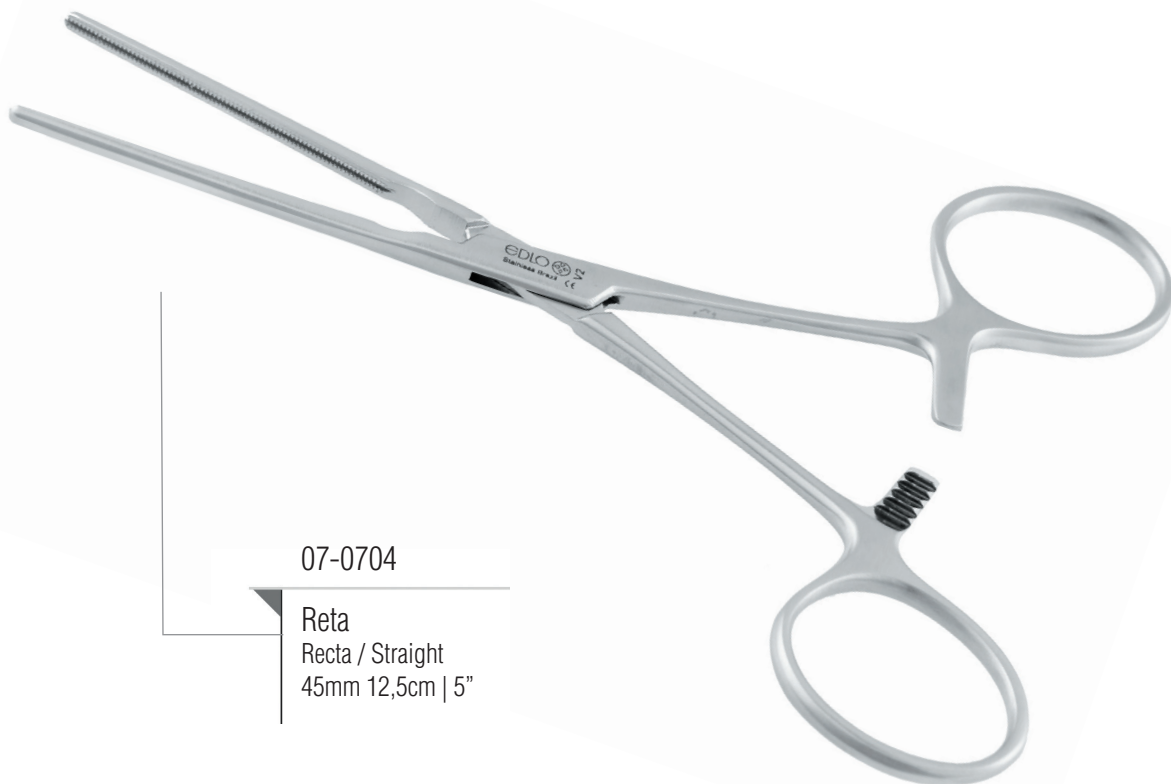

07-0704

Reta
Recta / Straight
45mm 12,5cm | 5"



07-0550

Reta
Recta / Straight
40mm 15,5cm | 6 1/2"



07-3032

Reta
Recta / Straight
65mm 18cm | 7"

De Bakey

07-0554

45° 12,5cm | 5"

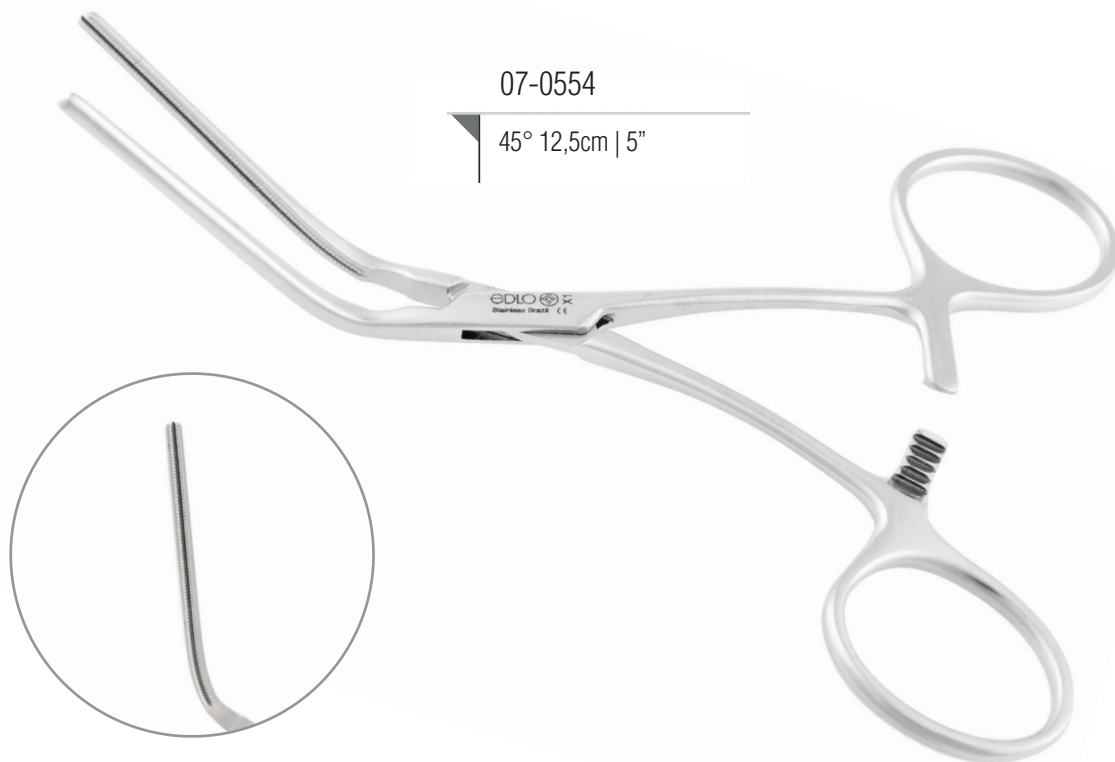

07-0702

40mm 90° 10,5cm | 4 1/4"



De Bakey Potts



07-0712

Angulada
Angular / Angled
21cm | 8 1/4"



07-0709

Curva
Curva / Curved
22cm | 8 3/4"



07-0710

Angulada
Angular / Angled
22cm | 8 3/4"



07-0721

Curva
Curva / Curved
21cm | 8 1/4"

De Bakey Potts

07-0711

Reta
Recta / Straight
21cm | 8 1/4"

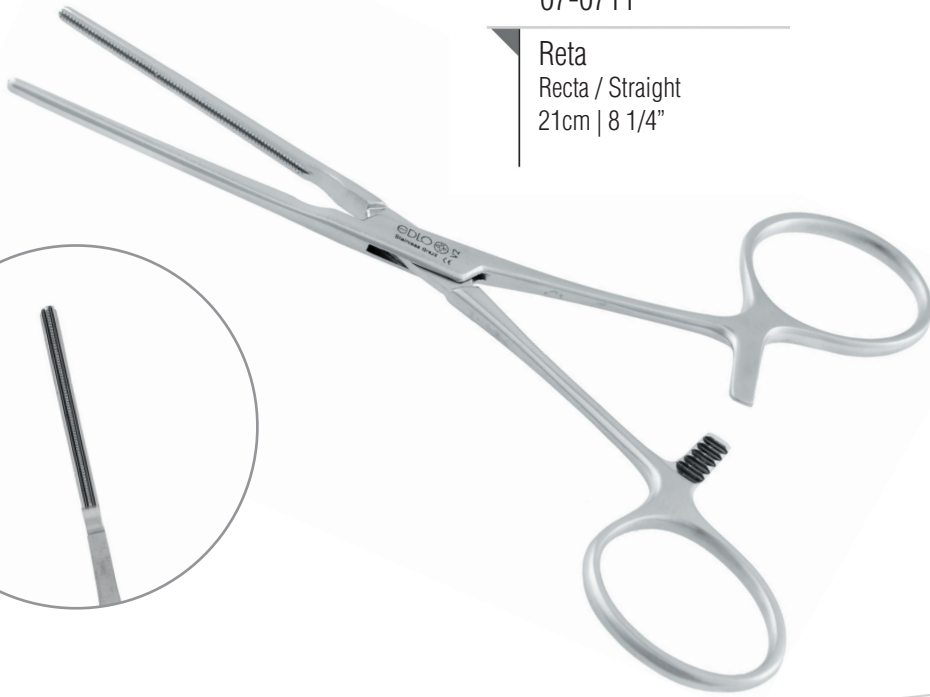

De Bakey-Beck

07-0798

17cm 6 3/4"

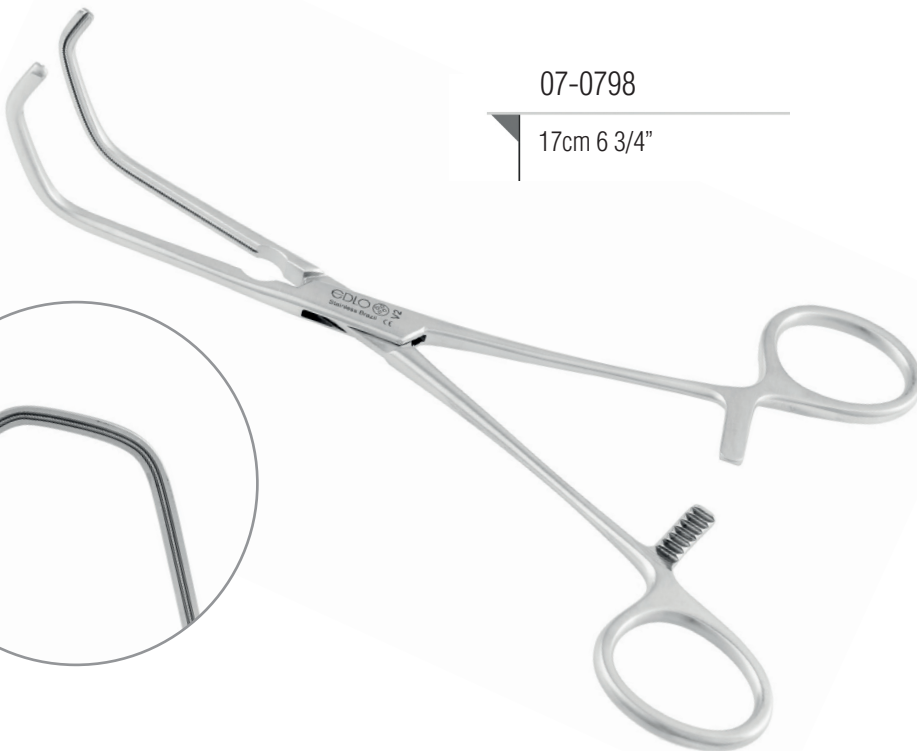

De Bakey-Glover



07-0540

Clamp de Anastomose Curvo
Anastomosis Clamp Curvo
Anastomosis Curved Clamp
50mm 17cm | 6 3/4"

Derra

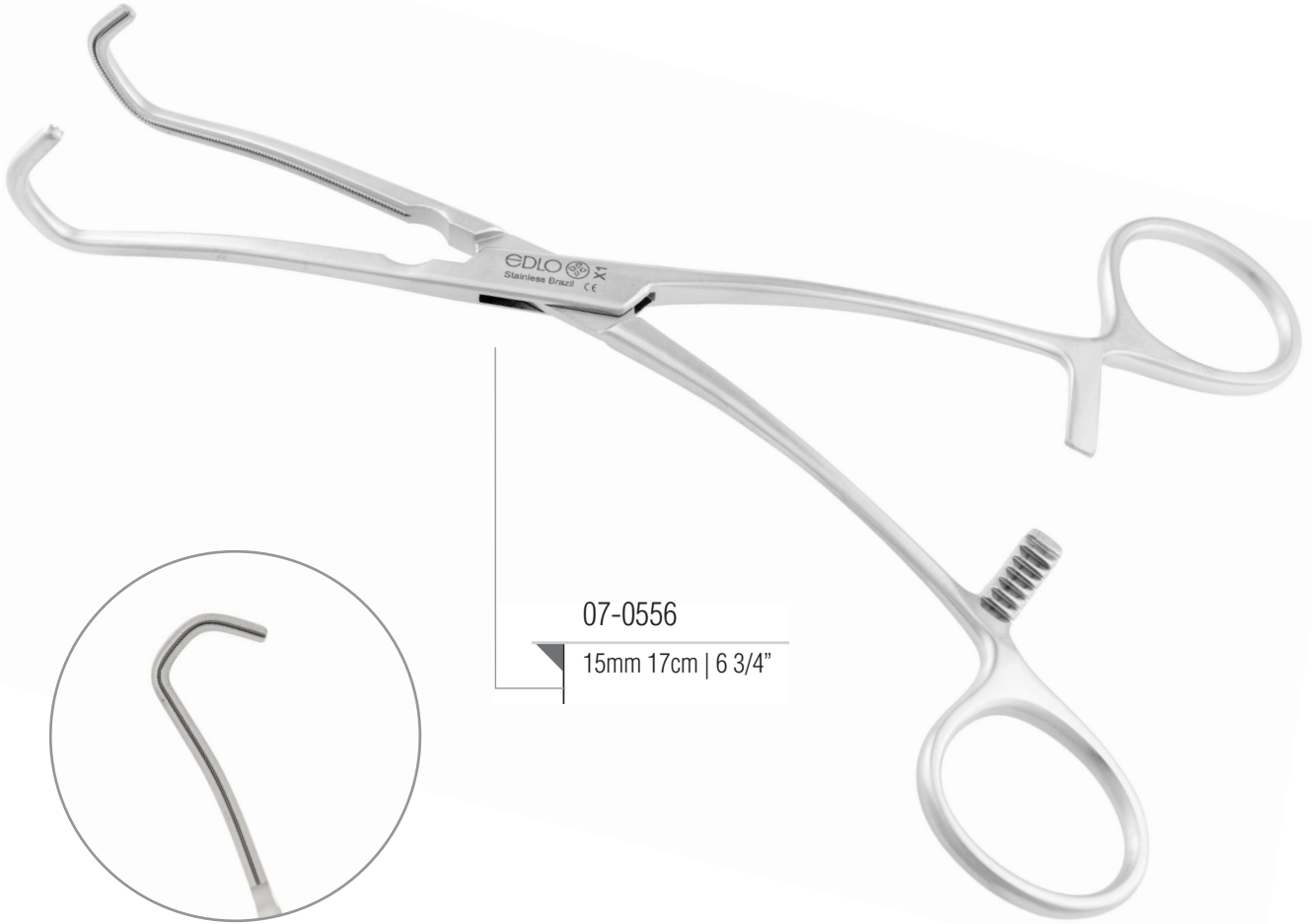

07-0556

15mm 17cm | 6 3/4"



07-0708

20mm 17cm | 6 3/4"



07-0557

25mm 17,5cm | 7"



07-2890

Forte
Fuerte / Strong
20mm Forte 17cm | 6 3/4"

Lambert-Kay

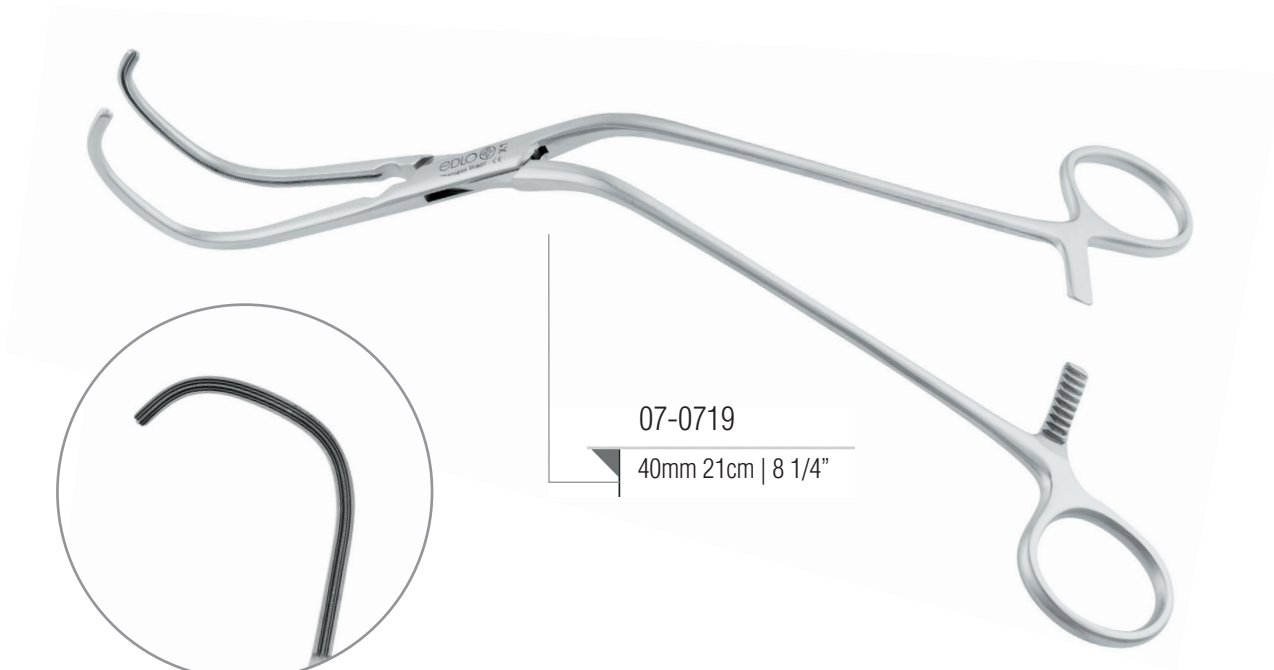

Leland-Jones

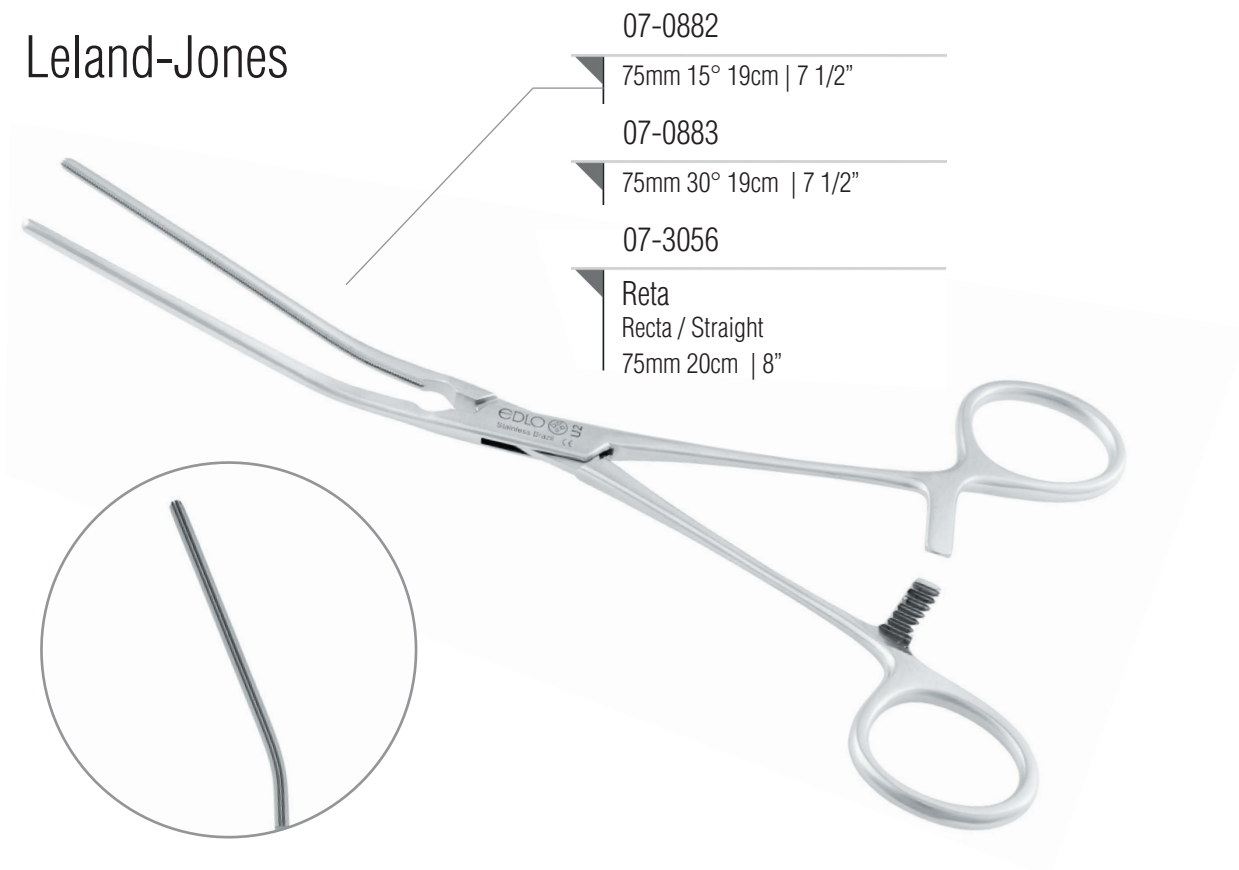

Ordenha

03-2610

14cm | 5 1/2"

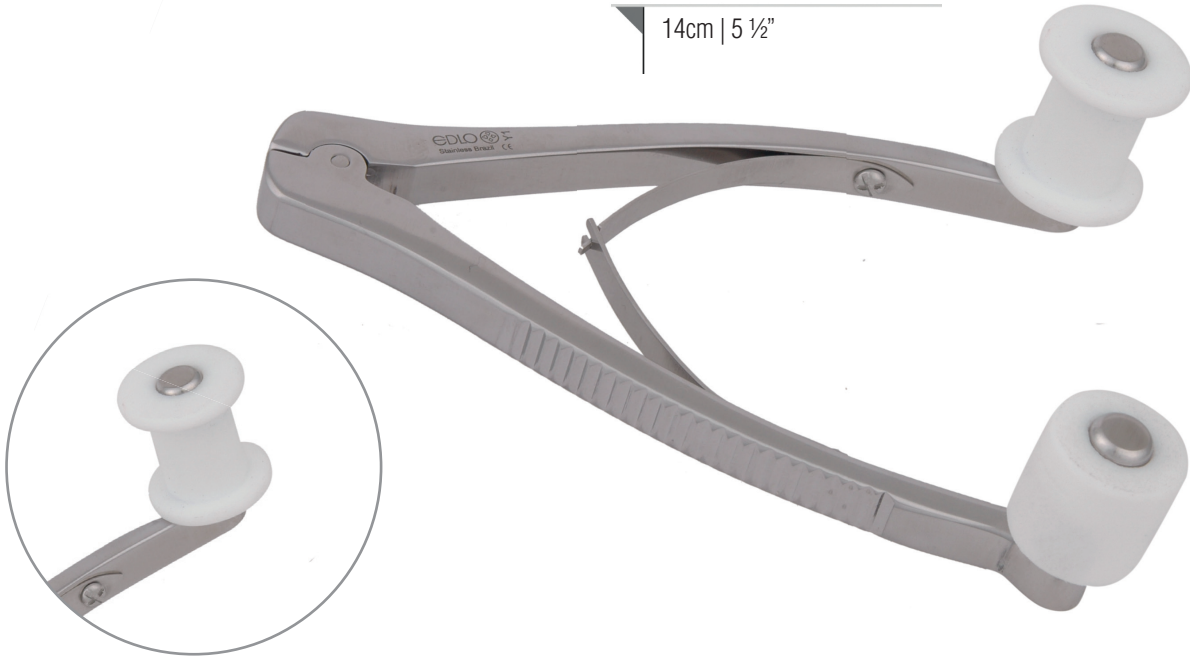

03-2602

21,5cm | 8 1/2"



Saca Cálcio

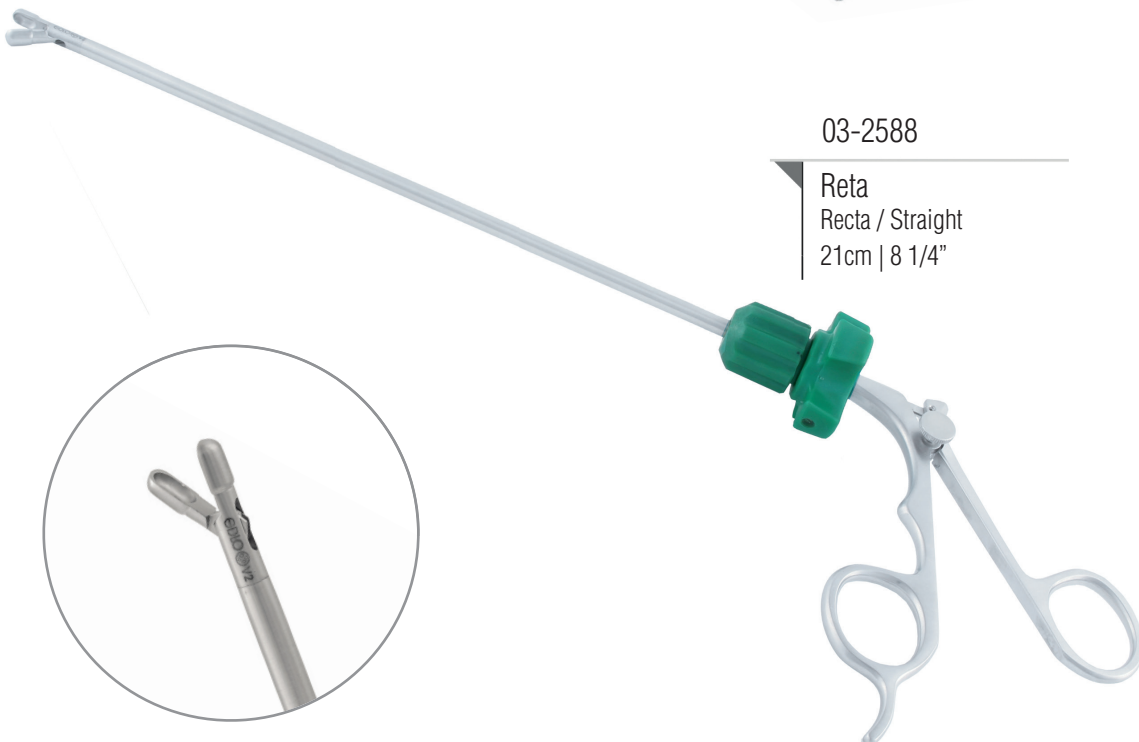
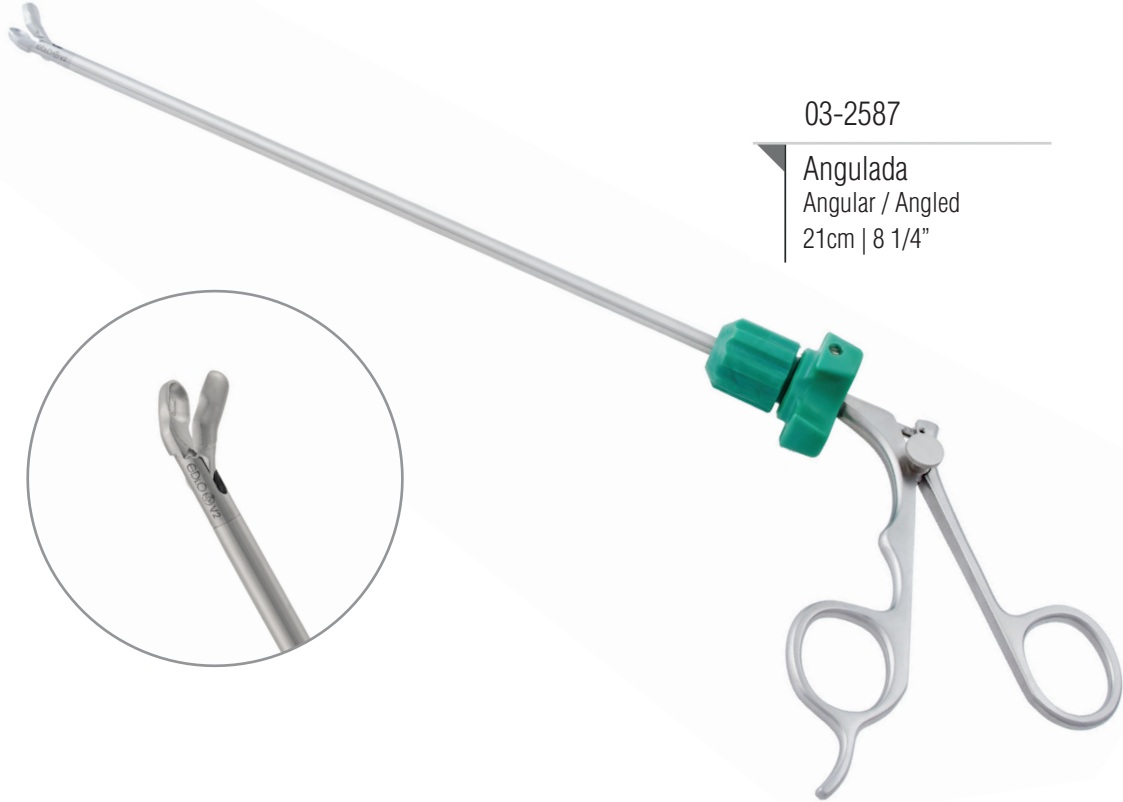

Pinça para Válvula Mitral

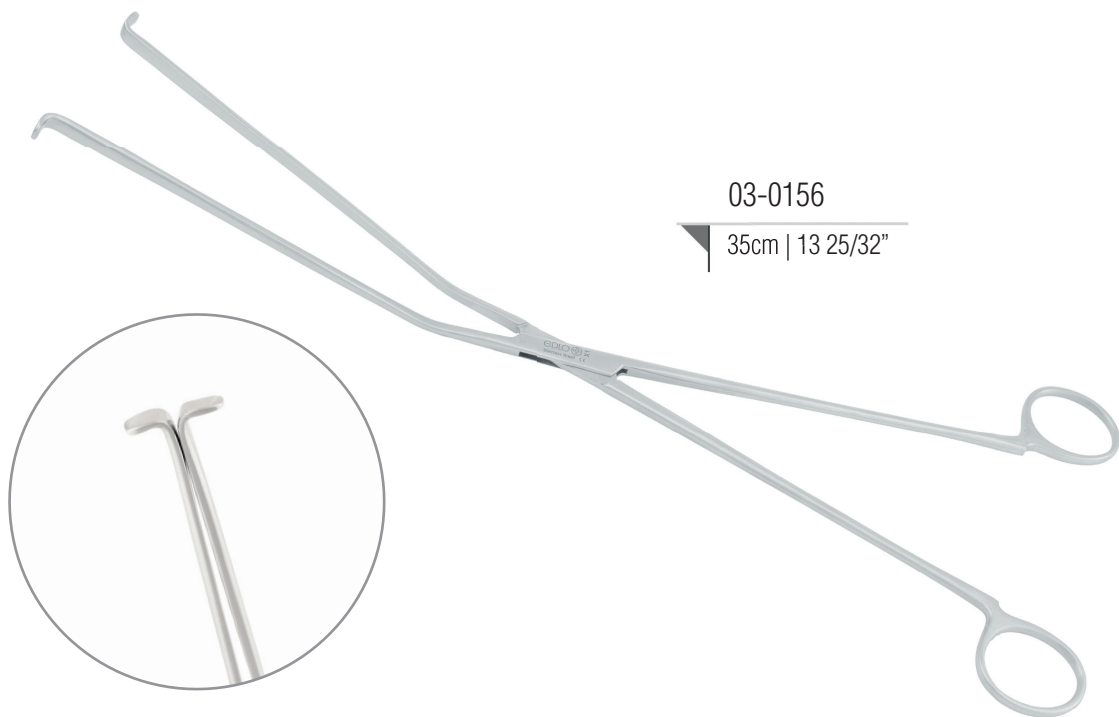
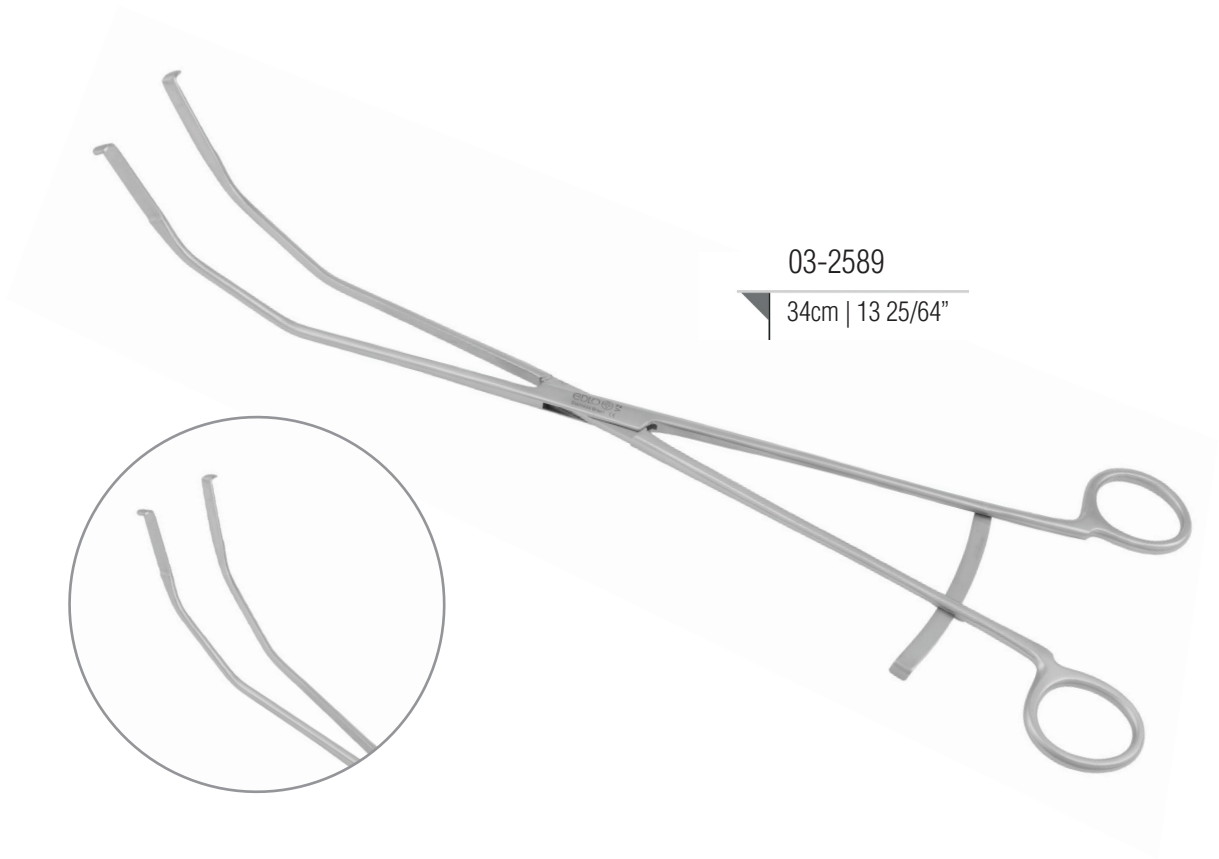

Satinsky

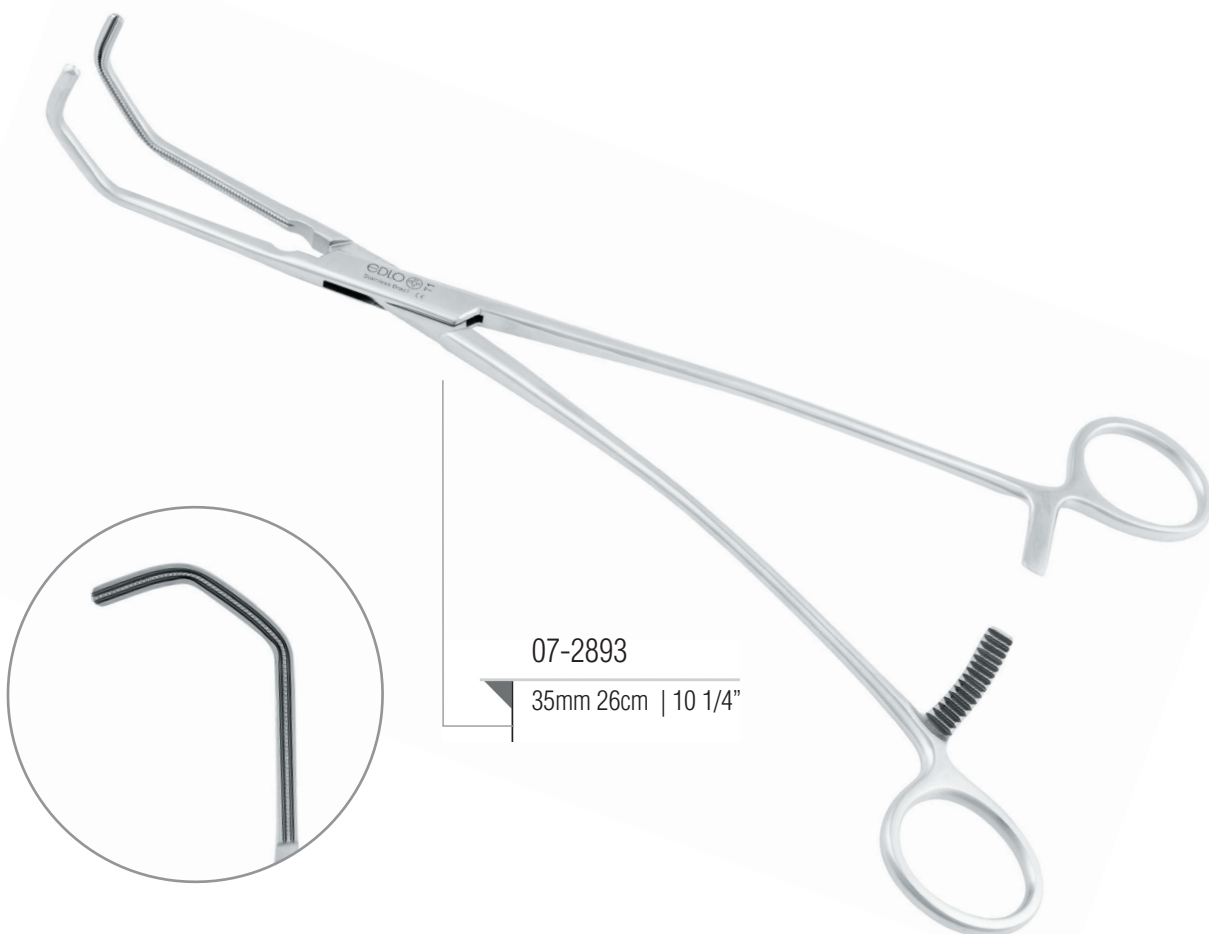

07-2893

35mm 26cm | 10 1/4"



07-0705

45mm 26cm | 10 1/4"



07-0548

55mm 26cm | 10 1/4"



07-0706

60mm 27,5cm | 11"

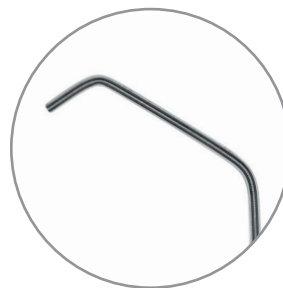

07-0707

75mm 28cm | 11"

Lahey



03-0221

Curva
Curvo / Curved
19cm | 7 1/2"



03-0222

Curva
Curvo / Curved
23cm | 9"



Lower



03-0223

19cm | 7 1/2"



Semb



03-0571

Curva
Curvo / Curved
24cm | 9 1/2"



Carótida

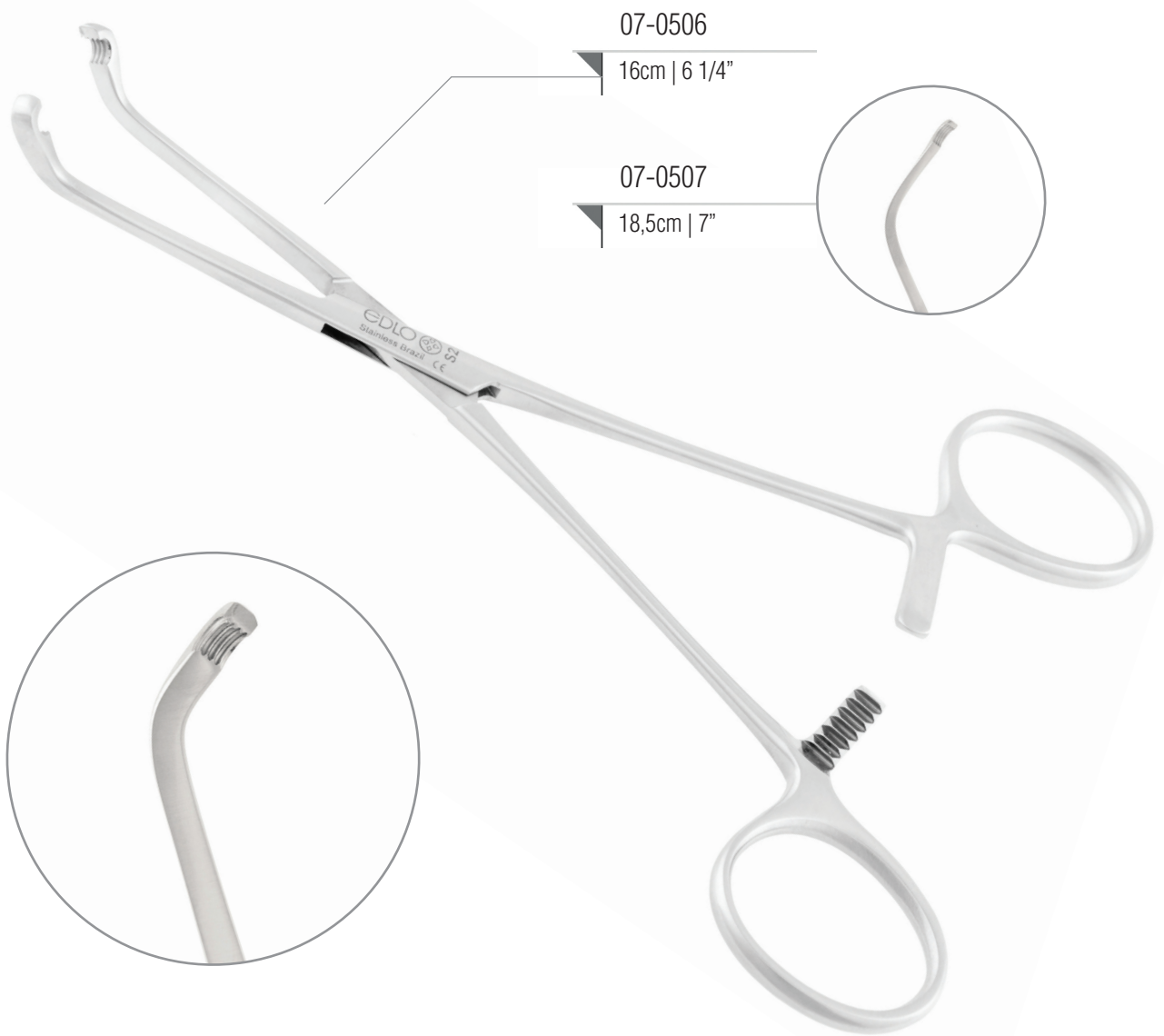

Denis



04-0486

20cm | 8"

Dietrich

Reta
Recta / Straight

07-0697

15cm | 6"

07-0698

20cm | 8"

07-0699

24cm | 9 1/2"

07-2894

18cm | 7"

07-2895

22cm | 8 3/4"

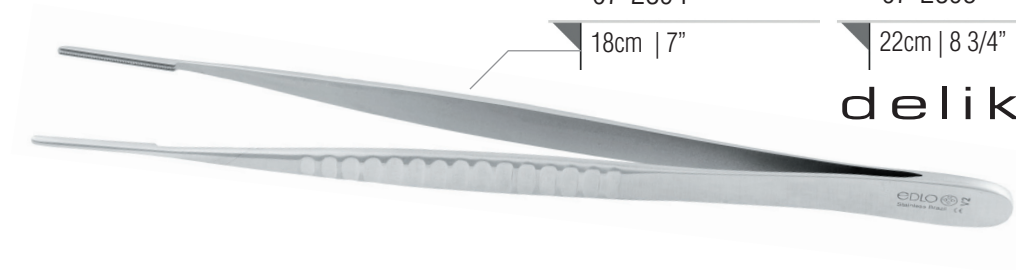

delikat

Dinkhuysen



04-2705

24cm | 9 1/2"

Punch Aórtico

07-0487

4.0mm 17cm | 6 3/4"

07-0489

5.5mm 17cm | 6 3/4"

07-2994

3.5mm 17cm | 6 3/4"

07-0488

4.5mm 17cm | 6 3/4"

07-0490

5.0mm 17cm | 6 3/4"

07-2995

3.0mm 17cm | 6 3/4"



Boyd

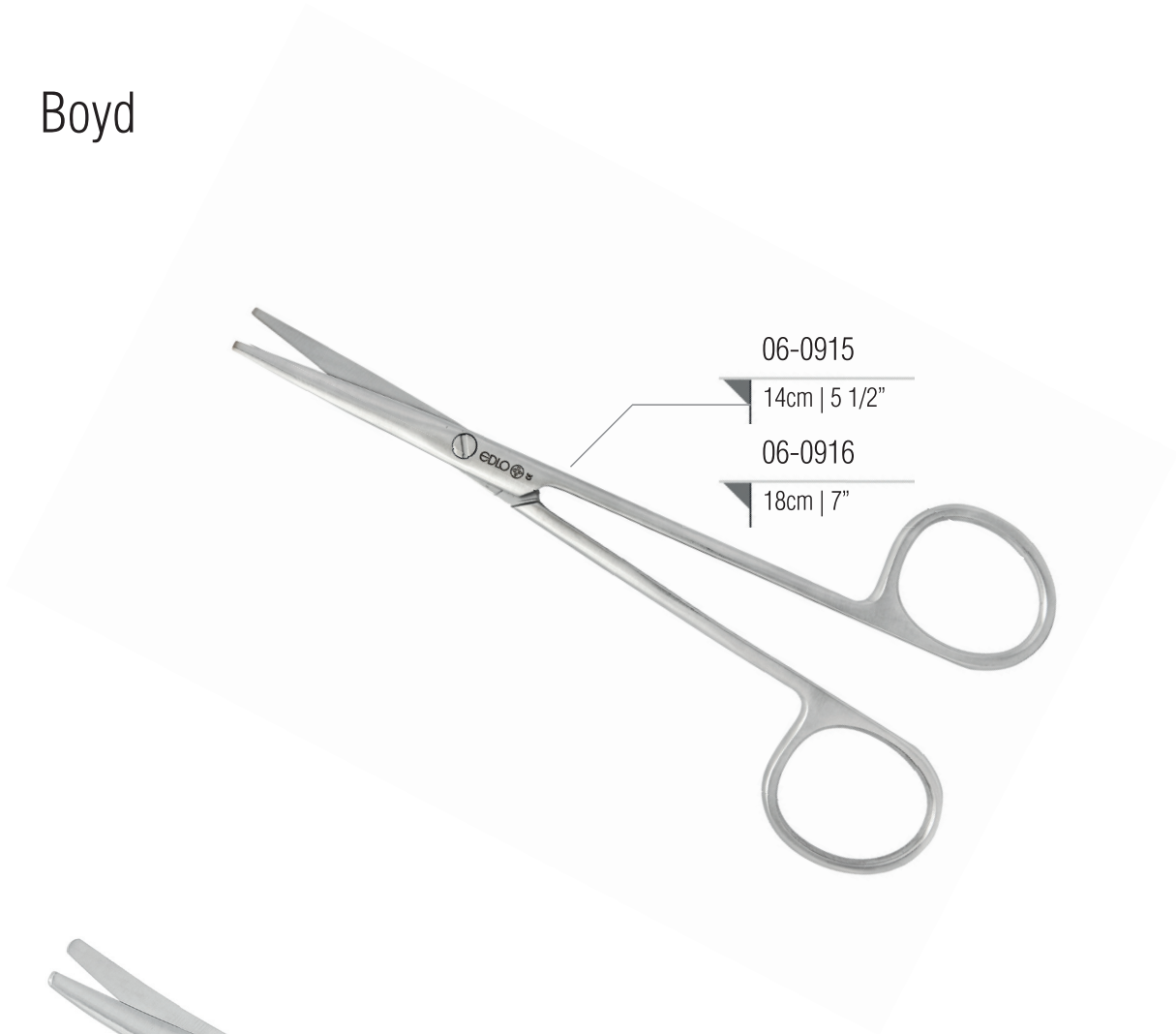

06-0915

14cm | 5 1/2"

06-0916

18cm | 7"

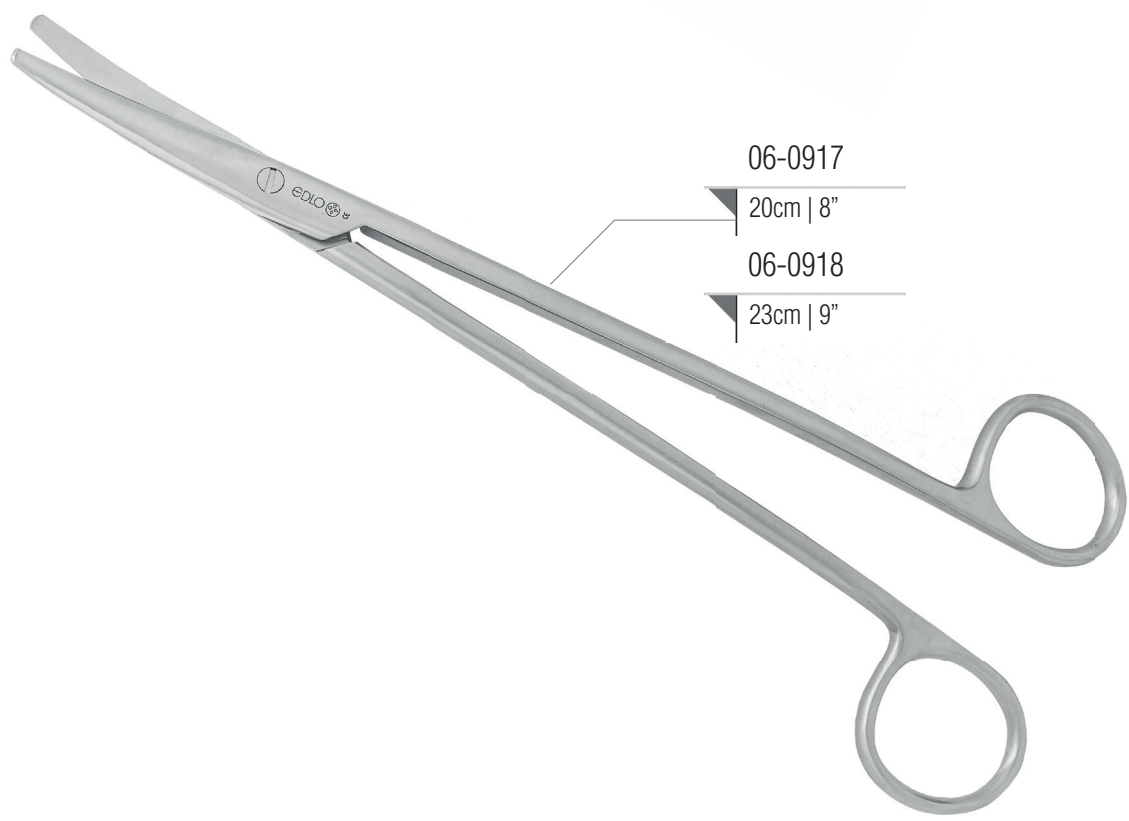

06-0917

20cm | 8"

06-0918

23cm | 9"

Boyd

06-0936

14cm | 5 1/2"

06-0937

18cm | 7"

Duracorte®



06-0938

20cm | 8"

06-0939

23cm | 9"

Duracorte®

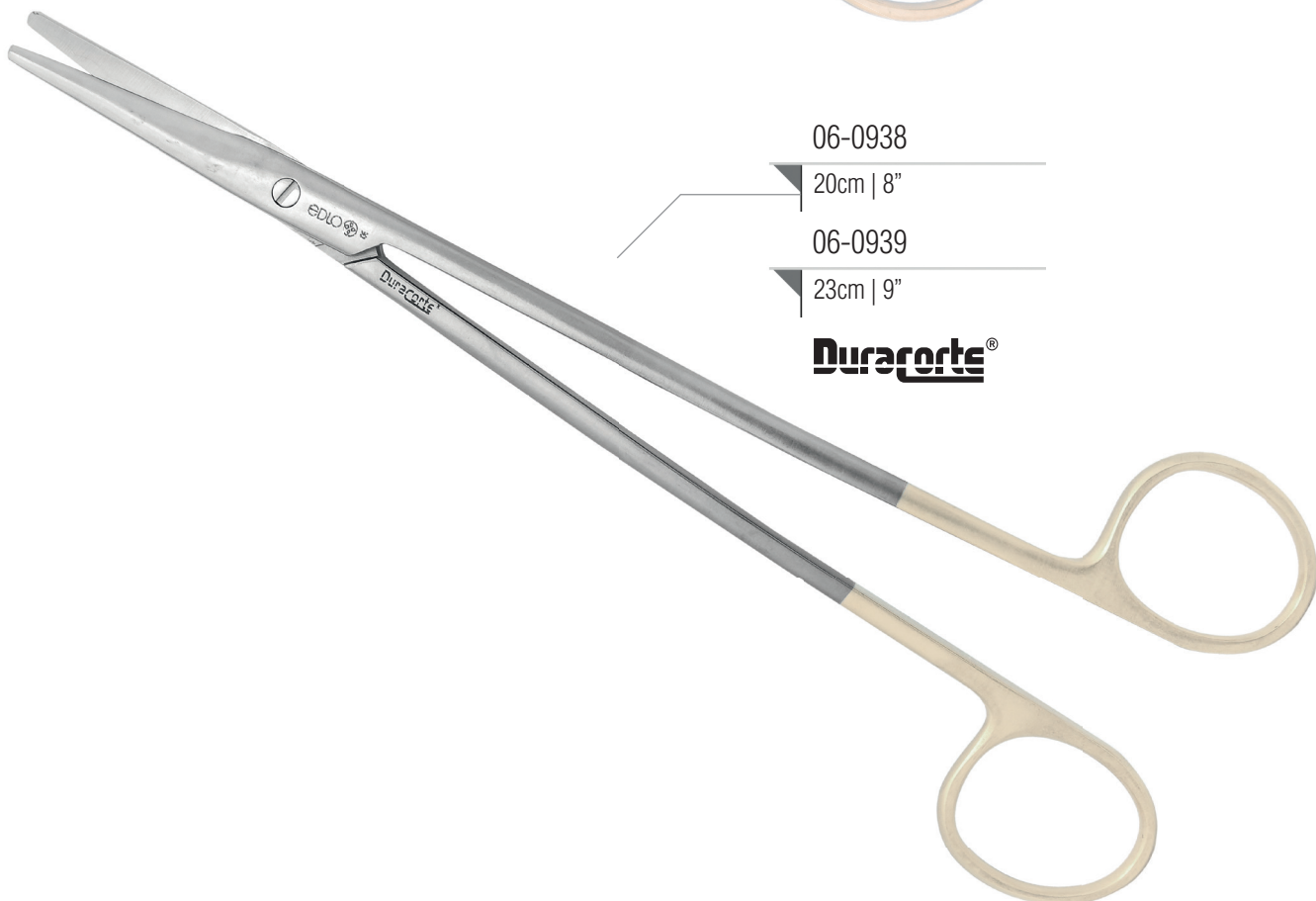

Dietrich

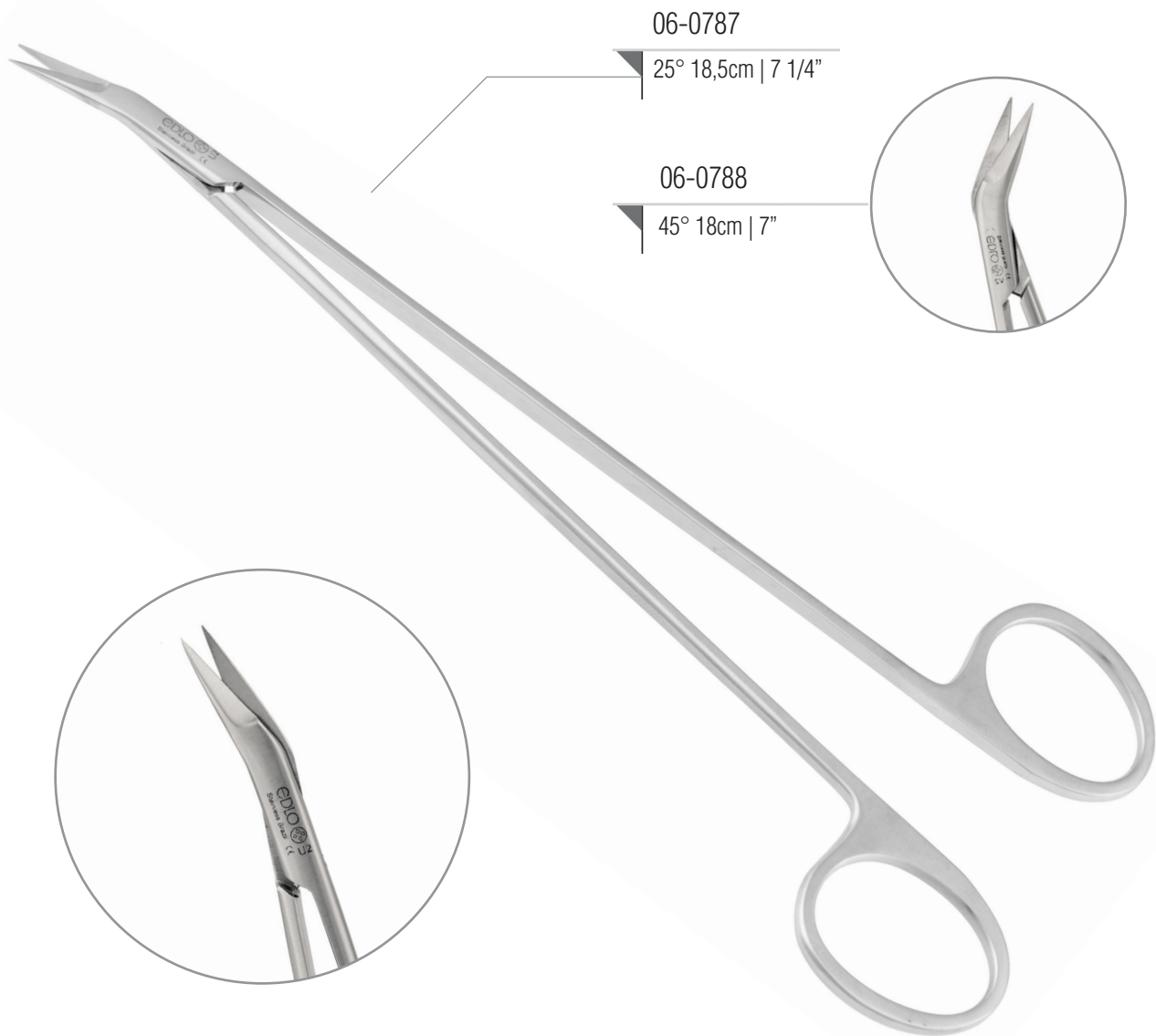

Dietrich



06-0791

125° 17cm | 6 3/4"



06-0790

90° 17cm | 6 3/4"



06-0789

60° 17,5cm | 7"

Dietrich

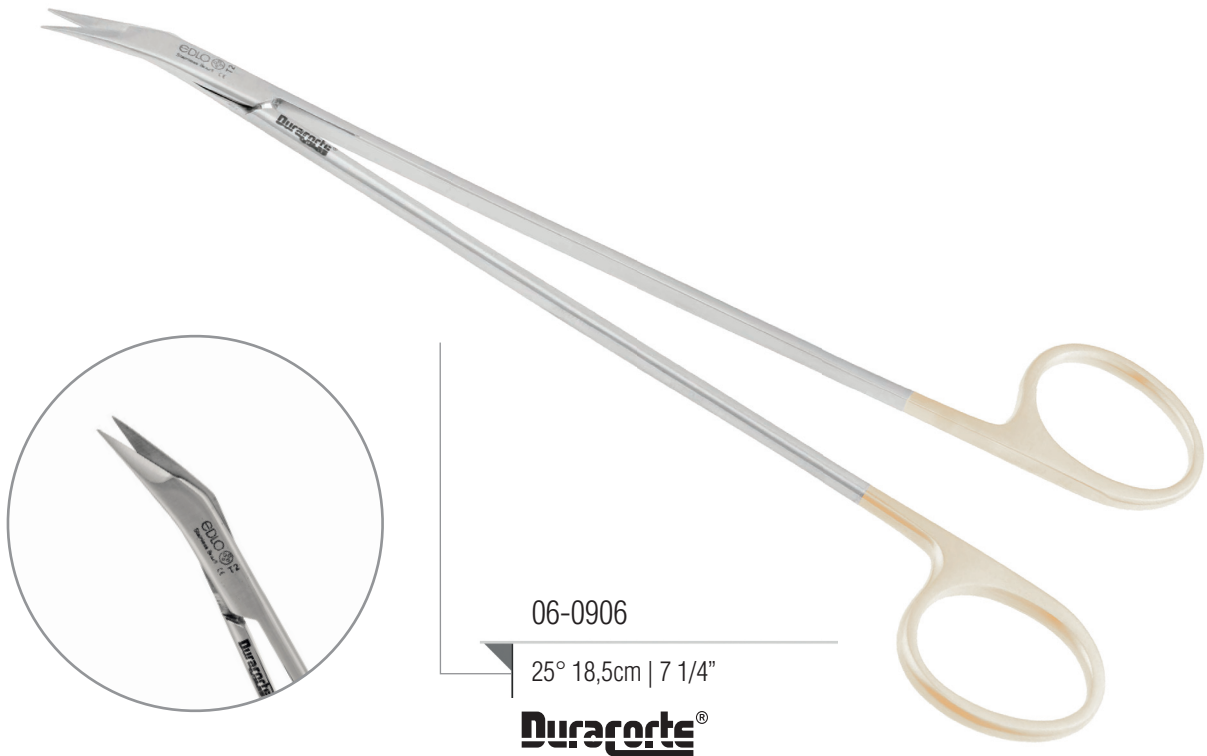

06-0906

25° 18,5cm | 7 1/4"

Duracorte®



06-0907

45° 18cm | 7"

Duracorte®



06-0908

60° 17,5cm | 7"

Duracorte®



06-0909

90° 17cm | 6 3/4"

Duracorte®



06-0910

125° 17cm | 6 3/4"

Duracorte®

Potts de Martel

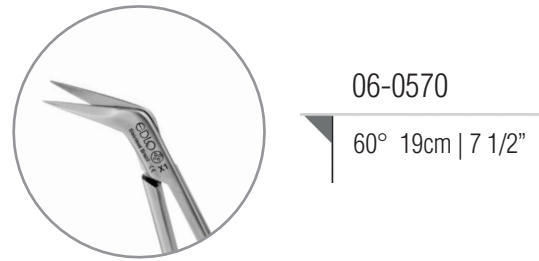
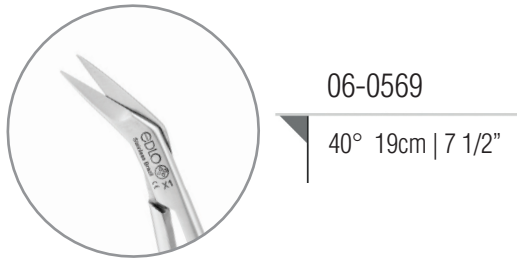
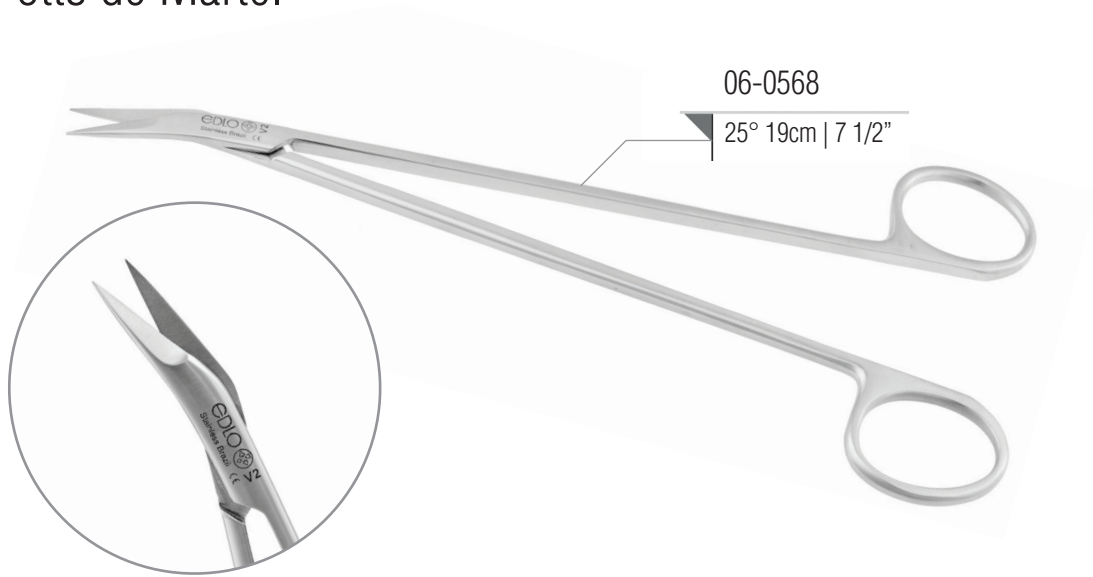

06-0648
25° 19cm | 7 1/2"
Duracorte®

06-0652
40° 19cm | 7 1/2"
Duracorte®

06-0653
60° 19cm | 7 1/2"
Duracorte®

Metzenbaum Cárdio

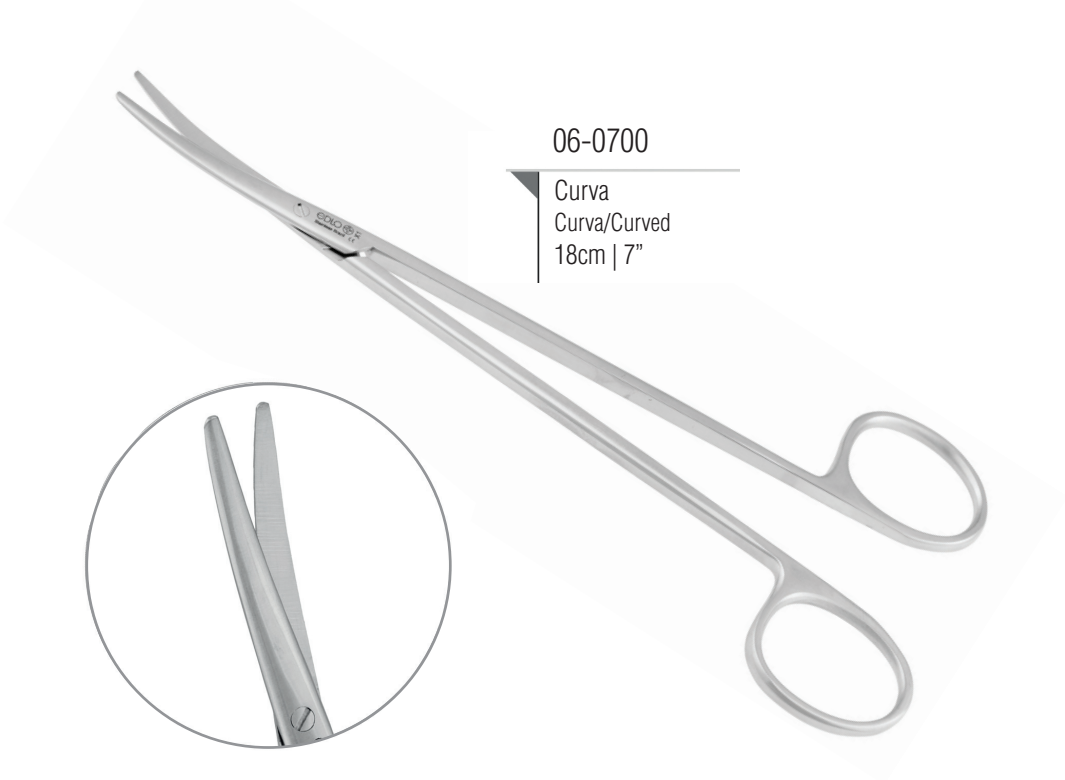

06-0700

Curva
Curva/Curved
18cm | 7"



06-0900

Curva
Curva/Curved
18cm | 7"
Duracorte®

De Bakey



10-0777

1,0mm 20cm | 8"

10-0778

1,5mm 20cm | 8"



10-0779

2,0mm 20cm
8"



10-0780

2,5mm 20cm
8"



10-0781

3,0mm 20cm
8"



10-0783

4,0mm 20cm
8"



10-0784

4,5mm 20cm
8"



10-0785

5,0mm 20cm
8"



10-0782

3,5mm 20cm
8"

10-3406

0,5mm 19cm
7 1/2"

10-3407

7,0mm 19cm
7 1/2"

10-3408

9,0mm 19cm
7 1/2"

Porta agulhas para Coronária

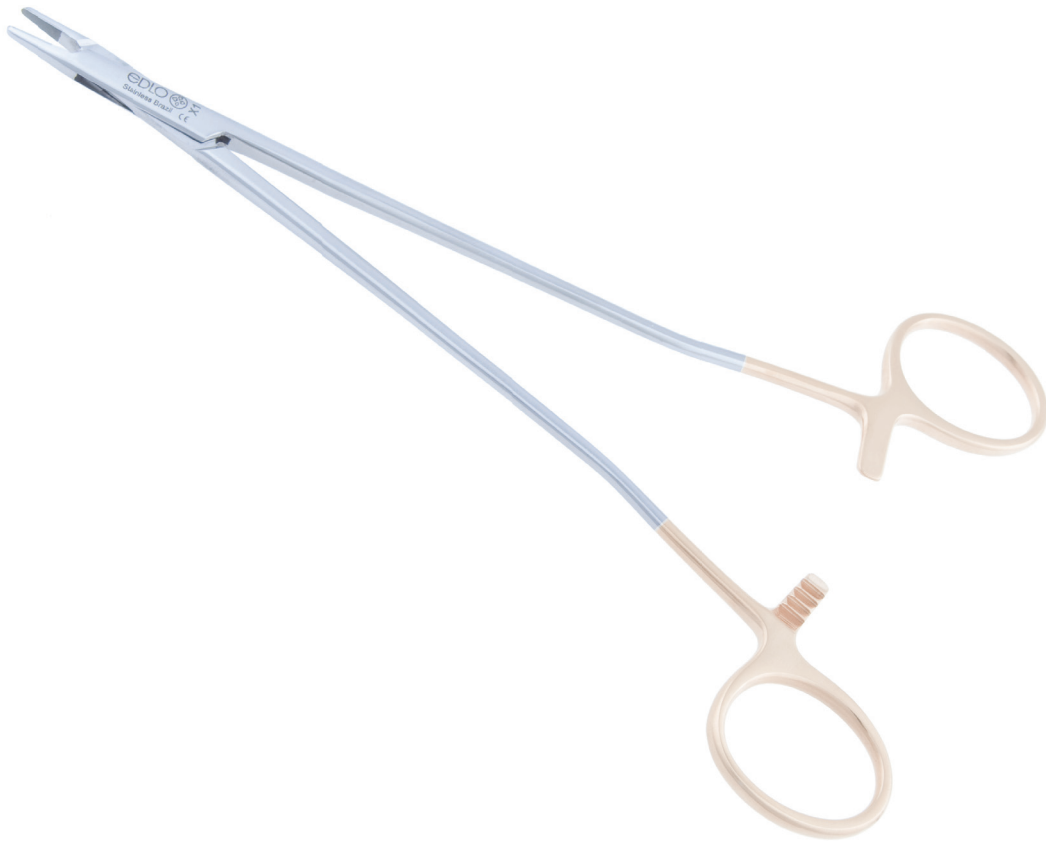

05-0929

C/ Vídia 17cm | 6 3/4"

HARDTIP®



05-0930

C/ Vídia 19cm | 7 1/2"

HARDTIP®



05-0931

C/ Vídia 22cm | 8 3/4"

HARDTIP®

Conjunto Flebo Extrator

10-3068





ITM Indústria de Tecnologias Médicas Ltda.

Rua Berto Círio, 751
Canoas - RS - Brasil - Cep 92420-030
Fone: +55 51 3052.3900

www.edlo.com.br

Siga-nos nas Redes Sociais:

 /edloitm

 @edloitm

 /edloitm

85-1211-3

Versão web: Fev/2024